

PT - LS

RUBBER EXPANSION/FLEXIBLE JOINT



PT - LS



PT-LS

RUBBER EXPANSION/FLEXIBLE JOINT

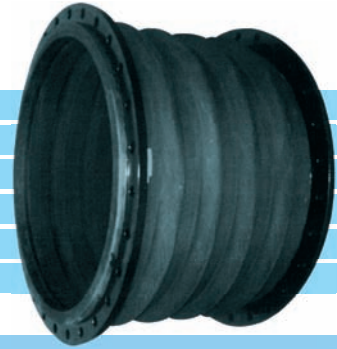

FEATURES & ADVANTAGES

1. Absorption of Movement

Proper arch of PT-LS connector and elasticity of rubber itself absorb large movement with small overall length.

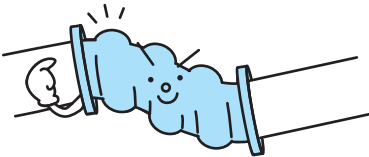

2. High Pressure Resistance

PT-LS connector provides max. working pressure 2.94 MPa (30 kgf/cm²) with our proper construction and special compound synthetic rubber reinforced by strong synthetic fibre. This pressure rating varies against sizes, please consult us.

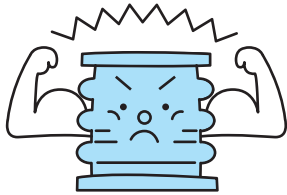

3. Vibration and Sound Absorption

Spring constant is made small with elasticity of rubber and proper design of arch and waist to result good vibration and sound isolation.

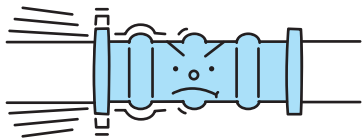

4. Custom Made

PT-LS connectors are custom made connectors. It is possible to make connectors to meet site requirements like fluid, pressure, temperature, overall length, connection, movement, etc.

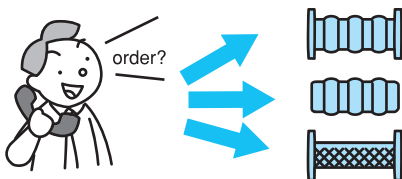

5. Large Displacement

PT-LS connectors have large movement of axial compression, elongation, lateral and angular movement independently or simultaneously, while metal connectors provide movement in one direction.

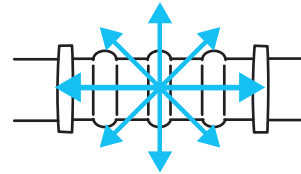

6. Great Recovery from Movement

When a metal connector is fully compressed, it assumes a permanent set, a rubber expansion joint continues to return to its original position.

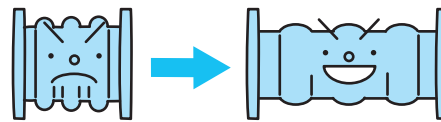

7. Excellent Corrosion Resistance

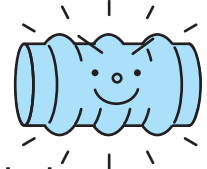

8. Neither Packing nor Gasket required

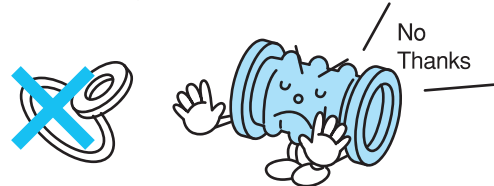

9. Variation

Various connections are provided by materials like polyvinyl chloride pipes (VP, VU), steel pipes, hume pipes, etc. and also by connection like flange, socket, welding, etc., which meet site requirement.

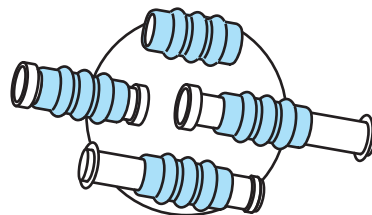

APPLICATIONS

PT-LS is widely used in :

- Water Supply Services
- Chemical Processing Plant
- Sewerage Treatment Plant
- Water Treatment Plant
- Air Purification Systems
- Electrical Generating Stations
- Drainage Systems
- HVAC Systems
- Marine Services

and many other aboveground or buried pipe line.

Some application examples related to civil engineering

1) Beside a structure

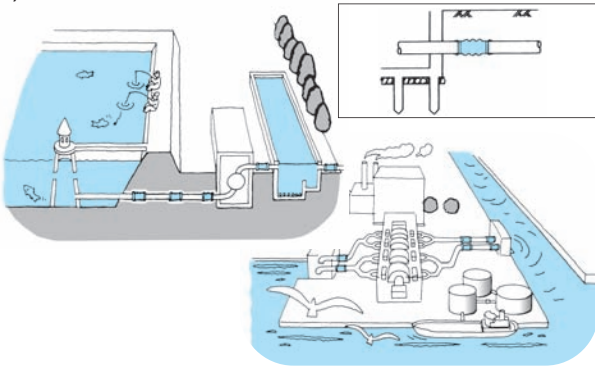

5) Under roads and railways

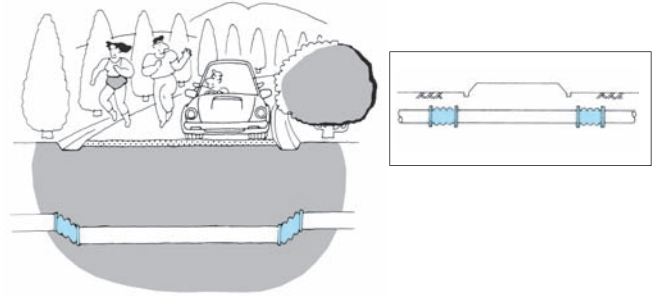

2) Beside valve & manhole

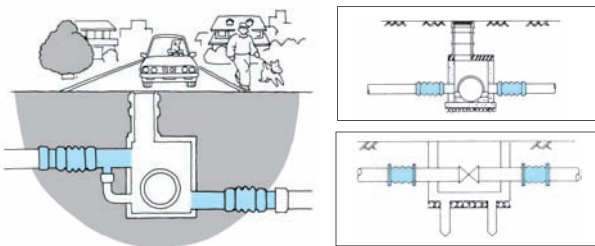

6) In reclamation areas and rural area

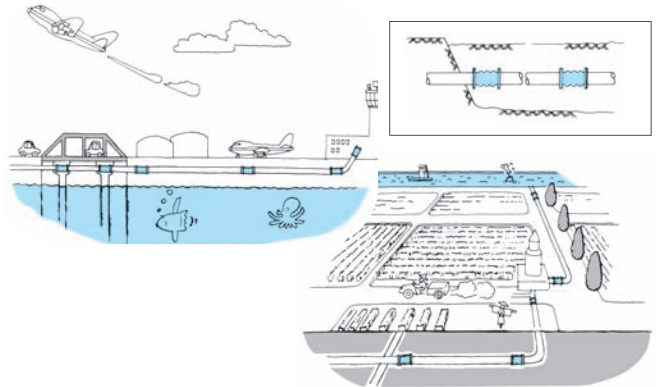

3) On or under an aqueduct bridge

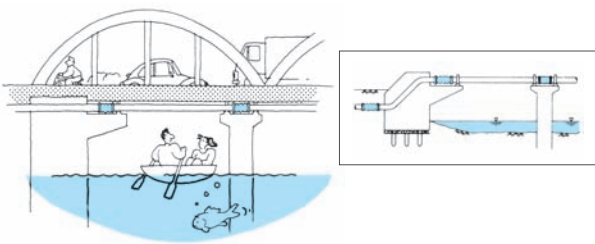

7) In pump houses

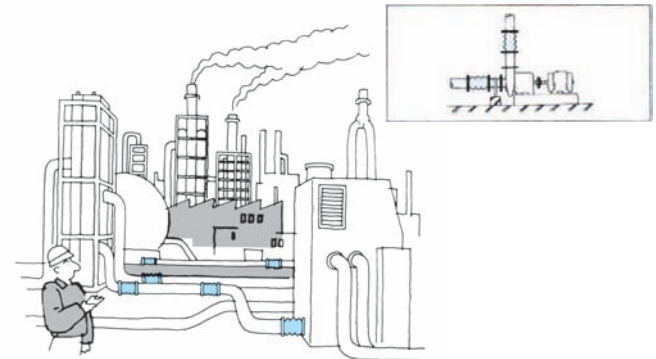

4) Between two structures

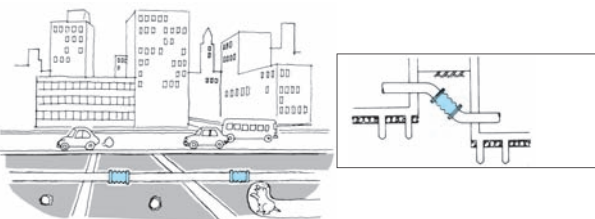

Some example photos

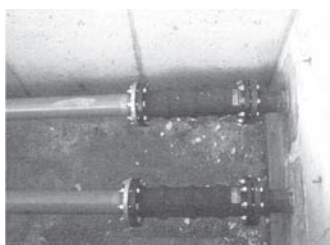

STRUCTURE & CONSTRUCTION OF PT-LS

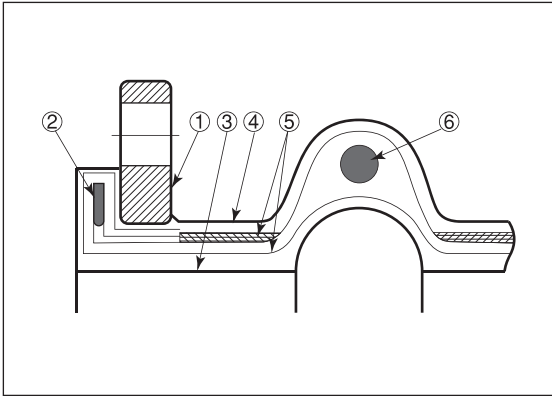

1. **Flanges** : The standard flange is made of mild steel. It is HD Galv. for Aboveground Type and coated with Tar Epoxy for Underground Type. It may be altered upon request.
2. **End Reinforcing Ring** : This end reinforcing ring provides max. strength and tightness between flanges.
3. **Inner Rubber** : The inner rubber core protects reinforcing fabric from penetration of the fluid and aging. This smooth, leak-proof core is made of neoprene, EPDM, chlorobutyl, hypalon, nitrile or other compound as desired for various service. Please consult us.

4. **Outer Rubber** : This is the exterior surface of the expansion joint, generally made of neoprene, giving good resistance to weather, ozone, aging, cracking, heat and corrosion. The other rubber materials are also available upon request. Please consult us.
5. **Reinforcing Fabric & Reinforcing Wire** : The reinforcing fabric is the flexible and supporting part between the inner core and outer cover. High strength synthetic fiber is used depending on pressure and temperature requirements. All fabric piles are penetrated with synthetic rubber to give max. adhesion under the conditions of pressure, vacuum and stress.
Note : Reinforcing wire has been replaced with reinforcing fabric. In case reinforcing wire is needed, please consult us.
6. **Arch Reinforcing Ring (for underground type and vacuum type)** This arch reinforcing ring is incorporated for the buried or vacuum services. General structure design of this ring is based on a load of 3 metres underground plus 25 tons of vehicle load.

DIMENSIONS & ALLOWABLE MOVEMENTS

Nominal Dia. (mm)	Standard Pressure Rating (Kgf/cm ²)	20 mm Lateral Movement 1 – Bellow (mm)			50 mm Lateral Movement 2 – Bellow (mm)			100 mm Lateral Movement 3 – Bellow (mm)			200 mm Lateral Movement 4 – Bellow (mm)		
		L	Elon.	Comp.	L	Elon.	Comp.	L	Elon.	Comp.	L	Elon.	Comp.
20	10	150	15	20	250	30	45	350	40	60	450	40	60
25	10	150	15	20	250	30	45	350	40	60	450	40	60
32	10	150	15	20	250	30	45	350	40	60	450	40	60
40	10	150	15	20	250	30	45	350	40	60	450	40	60
50	10	150	15	20	250	30	45	350	40	60	450	40	60
65	10	150	15	20	250	30	45	350	40	60	450	40	60
80	10	150	20	20	300	30	45	350	40	60	450	40	60
100	10	150	20	20	300	30	45	350	40	60	450	40	60
125	8	150	20	20	300	30	45	350	40	60	450	40	60
150	8	200	20	20	300	30	45	500	40	60	600	40	60
200	8	200	20	20	300	30	45	500	40	60	600	40	60
250	8	200	20	20	300	30	45	500	40	60	600	40	60
300	8	200	20	20	300	30	45	550	40	60	650	40	60
350	8	200	25	30	350	40	50	550	50	70	650	50	70
400	8	200	25	30	350	40	50	550	50	70	650	50	70
450	8	200	25	30	350	40	50	550	50	70	650	50	70
500	5	250	25	30	350	40	50	550	50	70	650	50	70
600	5	250	25	30	400	40	50	550	50	70	650	50	70
700	5	250	25	30	400	40	50	650	50	70	750	50	70
800	5	300	25	30	400	40	50	650	50	70	750	50	70
900	5	300	25	30	400	40	50	650	50	70	750	50	70
1000	4	300	25	30	450	40	50	700	50	70	800	50	70
1100	3	300	25	30	450	40	50	700	50	70	800	50	70
1200	3	300	25	30	450	40	50	700	50	70	800	50	70
1350	3	300	25	30	450	40	50	700	50	70	800	50	70
1500	3	350	25	30	450	40	50	750	50	70	950	50	70

L : Overall Length
Elon. : Elongation
Comp. : Compression

- Mass indicates the weight for underground type.
- Please use each movement within allowable movements.
- Information in the above table is for single movement only. In case of complex movements, correction is required. Please refer to the expression on page 7.

DIMENSIONS & ALLOWABLE MOVEMENTS (Cont.)

300 mm Lateral Movement

Nominal Dia. (mm)	No. of Bellows	Overall Length (mm)	Allowable Movement		
			L.M. (mm)	Elon. (mm)	Comp. (mm)
20	5	550	300	60	50
25	5	550	300	60	50
32	5	550	300	60	50
40	5	550	300	60	50
50	5	550	300	60	50
65	5	650	300	60	50
80	5	650	300	60	50
100	5	650	300	60	50
125	5	650	300	60	50
150	5	650	300	60	60
200	5	700	300	80	60
250	5	700	300	80	60
300	5	800	300	80	60
350	5	900	300	80	60
400	5	900	300	80	70
450	5	900	300	80	70
500	5	900	300	80	70
600	6	1000	300	80	70

400 mm Lateral Movement

Nominal Dia. (mm)	No. of Bellows	Overall Length (mm)	Allowable Movement		
			L.M. (mm)	Elon. (mm)	Comp. (mm)
20	7	750	400	80	50
25	7	750	400	80	50
30	7	750	400	80	50
40	7	750	400	80	50
50	7	750	400	80	50
65	6	750	400	80	50
80	6	750	400	80	50
100	6	750	400	80	50
125	6	750	400	80	50
150	6	750	400	100	60
200	7	850	400	100	60
250	7	850	400	100	60
300	7	950	400	100	60
350	7	1100	400	100	60
400	7	1100	400	100	70
450	7	1100	400	100	70
500	7	1100	400	100	70
600	7	1250	400	100	70

L.M. : Lateral Movement
 Elon. : Elongation
 Comp. : Compression
 A.M. : Angular Movement

- The above tables for 300 and 400 mm lateral movement are for G-Type (recommended). Please refer to illustration on page 6.
- Please apply each movement within an allowable movements.
- Information in the above table is single movement only. In case of complex movements, correction is required. Please refer to the expression on page 7.

PT-LS HIGH PRESSURE TYPE SPECIFICATIONS

Size	W/P 16~20 Kg/cm ²			W/P 30 Kg/cm ²		W/P 40 Kg/cm ²
	Min. Length (1 bellow)	Length (2 bellows)	Max. Length (3 bellows)	Min. Length (1 bellow)	Max. Length (2 bellows)	Min./Max. Length (1 bellow)
32A	200 mm.	250 mm.	350 mm.	200 mm.	250 mm.	200 mm.
40A	200 mm.	250 mm.	350 mm.	200 mm.	250 mm.	200 mm.
50A	200 mm.	250 mm.	350 mm.	200 mm.	250 mm.	200 mm.
65A	220 mm.	300 mm.	350 mm.	220 mm.	300 mm.	220 mm.
80A	220 mm.	300 mm.	350 mm.	220 mm.	300 mm.	220 mm.
100A	250 mm.	300 mm.	400 mm.	250 mm.	300 mm.	250 mm.
125A	250 mm.	300 mm.	400 mm.	250 mm.	350 mm.	250 mm.
150A	280 mm.	400 mm.	500 mm.	280 mm.	400 mm.	300 mm.
200A	300 mm.	400 mm.	500 mm.	300 mm.	400 mm.	-
250A	300 mm.	400 mm.	500 mm.	300 mm.	400 mm.	-
300A	300 mm.	400 mm.	550 mm.	300 mm.	450 mm.	-
350A	350 mm.	450 mm.	550 mm.	-	-	-
400A	350 mm.	450 mm.	550 mm.	-	-	-
450A	350 mm.	450 mm.	550 mm.	-	-	-
500A	350 mm.	450 mm.	550 mm.	-	-	-
600A	400 mm.	500 mm.	550 mm.	-	-	-

Remark : PT-LS other than above specifications are also available. Please consult us.

MOVEMENTS

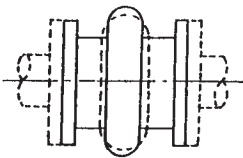
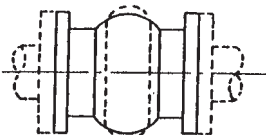
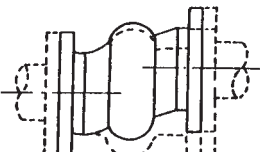
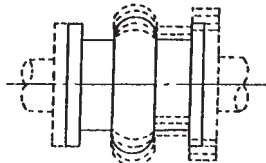
Absorption of : Axial Compression		Absorption of : Axial Elongation	
Absorption of : Lateral Movement		Absorption of : Vibration	

VARIATION

● **Flange**

It is possible to specify materials, standard and finish or painting.

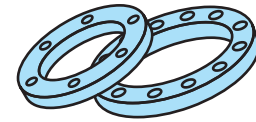

● **Rubber**

The rubber body material is changeable to meet site requirements. Please consult us.

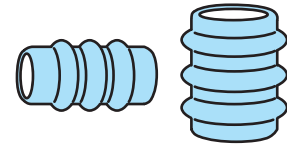

● **Overall Length**

Please refer to a table of standard overall length for each product herein. It is changeable if specified.

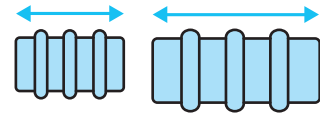

● **Underground Application**

The reinforcing ring is used against outer pressure of the buried service. It is designed in the base of a load of 3 metres underground plus 25 tons vehicle load. When a load of outer pressure more than that is anticipated, please specify it. For application of suction like vacuum, etc., please use this underground type connector. The standard finish of flanges for underground type will be hot dip galvanized+Tar epoxy coating.

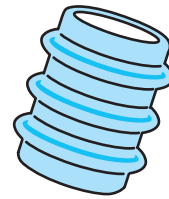

● **Filled Arch**

When inner rubber is required to be flat for prevention of sludge sedimentation, dead air space, fluid turbulent flow, etc., please specify this filled arch type.

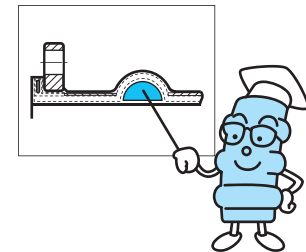

CONTROL UNIT

In case of the following conditions, control unit is recommended to use for protection of connectors.

- In case that it is hard to support reaction force (thrust) by pressure during the test operation or normal operation.
- In case that lateral movement more than the design is anticipated.
- In case that the connectors are anticipated to be compressed when installation.

● **W-Type (Welding)**

The triangle plates are welded directly to the flanges. (The picture shows 4-point support.)

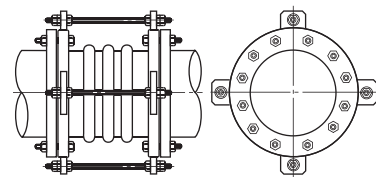

● **BP-Type (Back Plate)**

Triangle back plate type using bolt holes of counter flanges. (The picture shows 4-point support.)

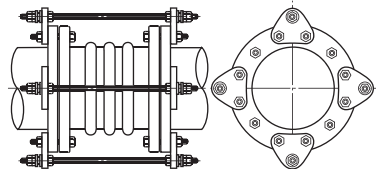

● **U-Type (Welding) ** New Type ****

Easy installation and removing type even in a small space. (The picture shows 4-point support.)

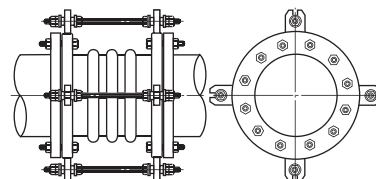

● **HINGE-Type (TWIN ACTION-Type)**

For a case that the excessive movement than the design is predicted.

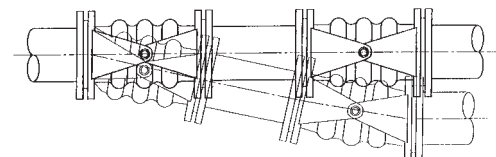

TYPE OF CONNECTION

ABOVEGROUND TYPE

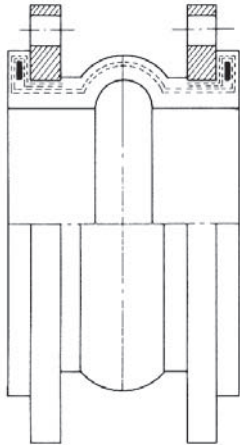

UNDERGROUND TYPE OR VACUUM TYPE

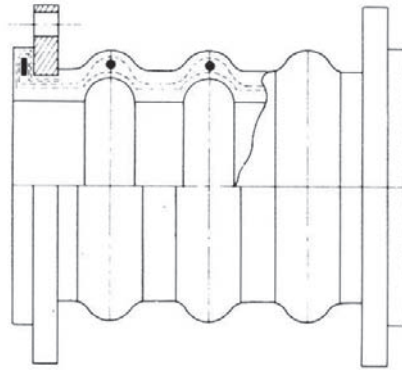

FILLED ARCH TYPE

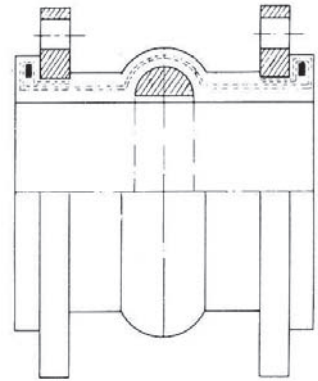

G TYPE

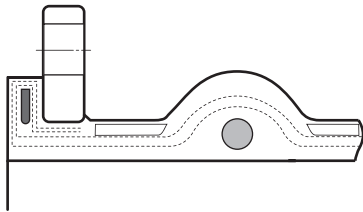

FULL-FACE TYPE

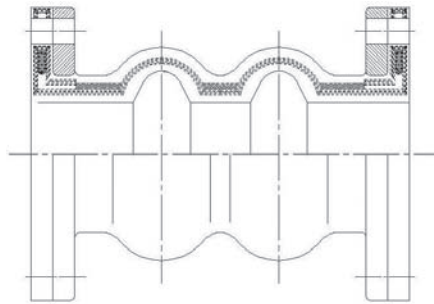

STRAIGHT TYPE

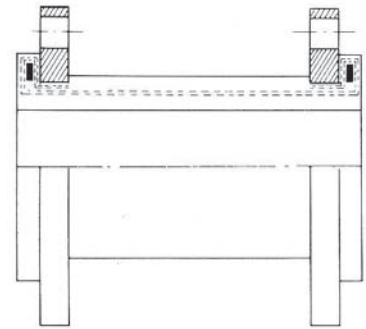

REDUCER TYPE

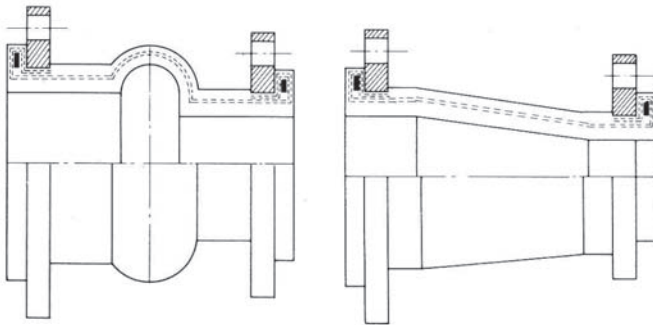

SOCKET TYPE

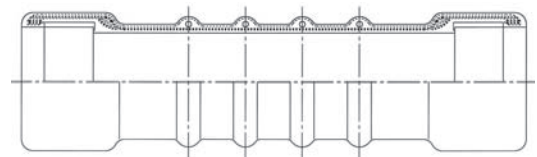

OTHER MODES OF CONNECTION

Double Bevel

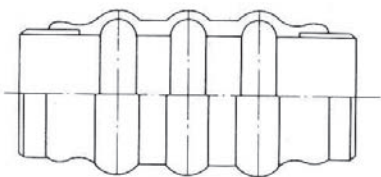

Hume Pipe

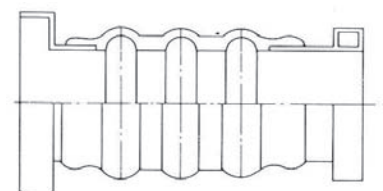

Single F + Single Bevel

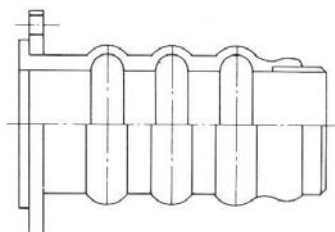

F Single Bevel + Single Bevel

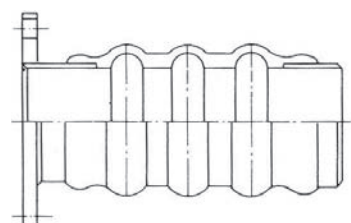

NOTES FOR CONNECTION

1. In rubber expansion joints, the packing face of the products might be damaged depends on the counter-pipe flange type. Please check the shape of the counter-pipe flange as follows.

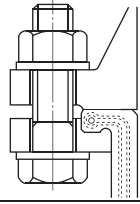
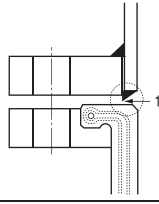
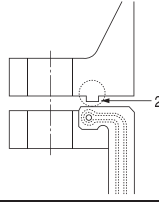
	Butt Welding Type Flange	Slip-On Welding Type Flange	Male-Female Flange
Shape			
Result	No problem. It's an ideal one because the inner dia. of rubber body and inner dia. of the mating pipe flange are almost same and a holding power for the packing is enough.	Apply a gasket to use. Burr by welding indicated by arrow mark 1 may damage the packing sealing face. Remove burrs by file or sand paper and apply a gasket if required.	Not applicable. Load per unit area will get bigger and the packing sealing face will be damaged due to small contact area with protrusion indicated by arrow mark 2 and packing sealing face of the body.

2. Fix the installation bolts from the rubber body side and tighten the nuts at the counter-pipe side. In case of the fully threaded bolts, note the bolts edge not to protrude extraordinarily the rubber body side.

3. Tighten the installation bolts in even in the diagonal order referring to the following table of the space after tightening the bolts and nuts. The abnormal installation like uneven bolts tightening, etc. will cause damage of the products.

Space after tightening the bolts and nuts

Nominal Dia. (mm)	Space after Tightening (mm)
20 - 125	8.5
150 - 500	13
600 - 800	18
900	20

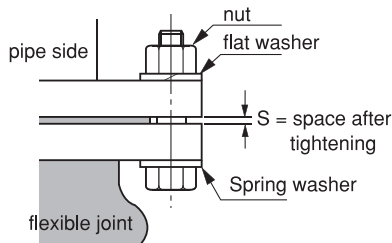

4. As to the installation bolts, refer to the following table.

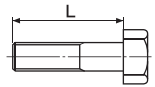

Nominal Dia. (mm)	JIS 10K		PN 10	
	Bolt	L (mm)	Bolt	L (mm)
15	M12	55	M12	55
20	M12	60	M12	60
25	M16	65	M12	65
32	M16	65	M16	65
40	M16	65	M16	65
50	M16	65	M16	65
65	M16	70	M16	70
80	M16	70	M16	70
100	M16	70	M16	70
125	M20	80	M16	80
150	M20	85	M20	85
200	M20	85	M20	85
250	M22	90	M20	90
300	M22	90	M20	90
350	M22	90	M20	90
400	M24	100	M24	100
450	M24	100	M24	100
500	M24	100	M24	100
600	M30	120	M27	120
700	M30	120	M27	120
800	M30	130	M30	130
900	M30	130	M30	130

These bolts are for standard PT-LS only.

Bevel Welding Connection

When connecting PT-LS Bevel Type, pay attention to protect the products from heat transmission.

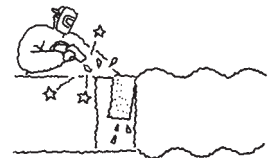

CORRECTION FOR COMPLEX MOVEMENTS

Allowable movements show max. single movement only. In case of complex movements, please follow the below expression for correction.

$$C. EL. C. = A. EL. C. \times \{1 - (L.M./A.L.M. + A.M./A.A.M.)\}$$

- C. EL. C. = Correct Elongation and Compression
- A. EL. C. = Allowable Elongation and Compression
- L.M. = Lateral Movement
- A.L.M. = Allowable Lateral Movement
- A.M. = Angular Movement
- A.A.M. = Allowable Angular Movement

(Example) For PT-LS connector 300A of 200 lateral movement, correct elongation will be as follows when lateral movement 150 mm. is required and max. allowable elongation is 40mm.

$$\text{Correct Elongation} = 40 \times \{1 - (150/200 + 0)\} = 10 \text{ mm.}$$

(For PT-LS connector, please always calculate as A.M./A.A.M. = 0)

In case PT-LS connector for 200 mm lateral movement is deflected 200 mm, allowable elongation will be '0'. In case PT-LS connector is deflected 200 mm and further allowable elongation is required, please apply PT-LS connector for 300 mm lateral movement.

NOTES OF TRANSPORTATION

1. Use a cloth lifting device (nylon sling) always in lifting and hanging during transportation.
2. The body is made of rubber. Do not transfer the products with a hook, steel pipe and fork of fork lift truck.
3. Do not give a big shock to the products. Do not roll over the products on the gravel, uneven surface, etc.

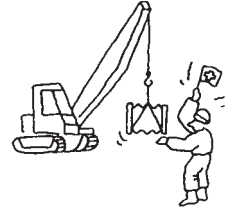

NOTES OF RE-BURYING

1. When re-burying, do not use soil including debris, macadam, wood chips, etc.
2. Bury the products in the ground pressing tightly soil and sand for re-burying every 30 cm depth. Do not bury the products at one effort up to the re-burying ground.
3. If soil pressing is not enough, the products may be loaded with excessive displacement than allowance in early stage. When insufficient soil pressing is anticipated, calculate the design movements including subsidence after installation.
4. Pay attention not to damage the products when soil pressing.

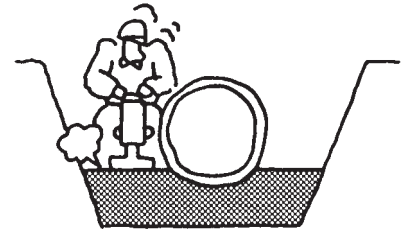

HANDLING MANUAL

Notes of Use

1. Damage of Body

Please check existence of damage on the body before use. If any damages are found out especially on the packing area, inner rubber, etc. do not use the products.

2. Operating Conditions

Please use the products checking max. working pressure and temperature to be within the working conditions.

3. Valve Position Checking

The products might be damaged by improper operation like complete shut-off operation, etc. Please check the valve position of 'Open-Close' securely when operation.

4. Valve Operation

Please operate the valve not to flow liquid suddenly.

5. Flow Velocity through Pipe

Please use the products in less than 3m/sec. of flow velocity through the pipe.

6. Adhesion

Please pay attention not to adhere oils and fats, organic solvent (thinner, toluene, etc.), acid, alkali, etc. to the products. If adhered, wipe off at once.

Notes of Storage

1. Pay attention to protect the products from damage during transportation and storage. If damaged, do not use the products.
2. In case of storage for a long time, avoid the direct rays of the sun and store the products in the cool and dark place.
3. Do not leave the products in the place in more than 40 Degree Celsius and excessive moisture for a long time.
4. Protect the products from fire and heat.
5. Do not load to the products.

Notes of Installation

1. In case of the products in displacement, pay attention to the products not to touch the structure and/or equipment (especially sharp edge).
2. Measure and make alignment accurately not for unnecessary outer force (compression, tension, torsion, etc.) to add when the products are connected to the pipe.
3. When welding or cutting the pipe nearby after installation, protect the products with cover like the SPARK-GUARD from sparks. In case heat transmission is anticipated, take some measure like taking off the products from the pipe, etc.
4. When installation to the outdoor pipe, make lagging to the products to prevent the rubber body ageing.
5. In case the products are used to the pump for the purpose of vibration isolation, refer to the followings for installation.

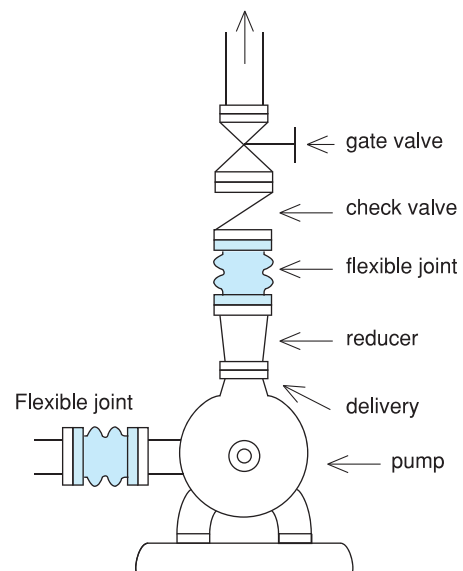

ANCHORING AND GUIDING THE PIPING SYSTEM

Pipe connectors can only be effective if correctly installed. Special attention must be paid to anchor points due to the force imposed by internal pressure. The proper location of rubber expansion joints is close to a main anchoring point. Following the joint in the line, a pipe guide or guides should be installed to keep the pipe in line and prevent undue displacement of the line. It is a simple application of a joint to absorb the elongation and compression of a pipeline between fixed anchor points.

● **Anchor Installation**

When a rubber expansion joint is used, anchors (fixing points) with sufficient strength are required. The installation locations and types of anchors are as follows.

● **Main Anchor (Main Fixing Point)**

- You will notice that in all cases solid anchoring is provided at the following locations.
- End section of straight piping installed with a closed plate.
 - Bending section where flow direction changes.
 - Between the 2 expansion joints whose piping diameters differ due to the use of a reducer.
 - Section with a valve installed at the piping section between 2 expansion joints.
 - Inlet section of branch piping with unrestricted expansion joint.

● **Intermediate Anchor (Intermediate Fixing Point)**

Intermediate section of each rubber expansion joint, when 2 or more rubber expansion joints are used between the main anchors. Anchor base (installation leg) section of duplex type expansion joint.

● **Calculation of Thrust**

When rubber expansion joints are installed in the pipeline, the static portion of the thrust is calculated as product of the area of the I.D. of the arch of the rubber expansion joint times the max. pressure (design or test) that will occur with the line. The result is a force expressed in kgf.

$$T = \frac{\pi}{4} (D)^2 (P)$$

- T = Thrust (kgf)
- P = kgf/cm²
- D = Arch I.D. (mm)

● **Installation of Guides**

In order for a rubber expansion joint correctly elongation and compression, guides are required for the alignment of the expansion joint with the pipe and also for the natural transmission of a force required for the movement in the axial direction to those guides. Install each guide at the following intervals.

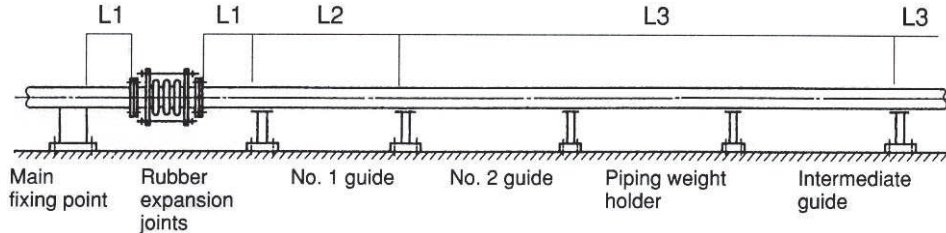

- L1 = Distance between rubber expansion joint and first No. 1 guide
- L2 = Distance between No. 1 guide and No. 2 guide
- L3 = Distance between No. 2 guide and intermediate guide

Obtain the max. installation interval of each guide from the following equation. In addition, the intermediate guide interval L3 can be obtained from the following figure of relationship with guide interval (L) and max. working pressure.

$$L1 \leq 4D \quad L2 \leq 14D$$

D = Outer Pipe Diameter (mm)

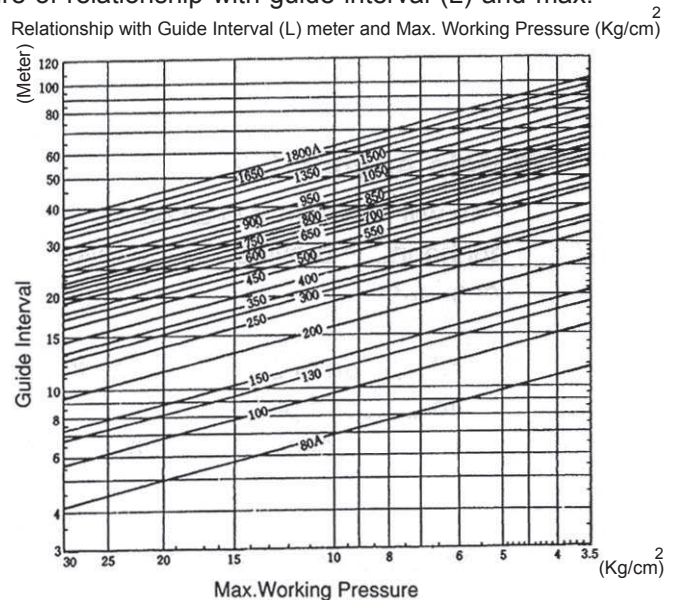
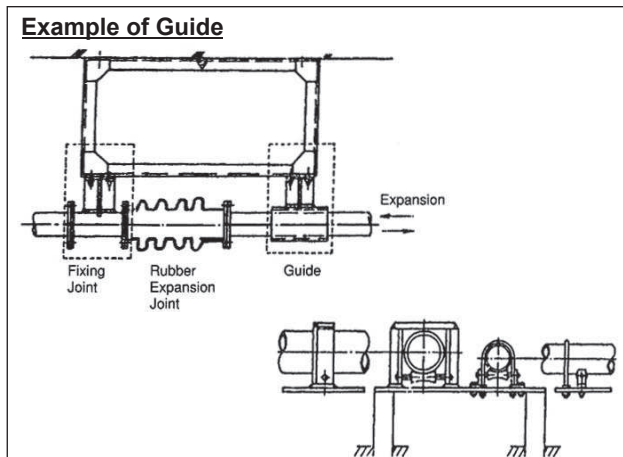

PT-LS DESIGN SHEET

Customer					
Project Name					
Size	Nominal Diameter	()A			
	No. of Arch	()			
	Overall Length	()mm			
Application		<input type="checkbox"/> Aboveground <input type="checkbox"/> Underground			
End Connection	Flange	Standard	<input type="checkbox"/> JIS ()K <input type="checkbox"/> BS4504 PN () <input type="checkbox"/> ANSI ()# <input type="checkbox"/> DIN PN ()		
		Material	<input type="checkbox"/> SS400 <input type="checkbox"/> SS304 <input type="checkbox"/> Others <input type="checkbox"/>		
		Finish	<input type="checkbox"/> Unichrome <input type="checkbox"/> H.D.Galv. <input type="checkbox"/> Tar Epoxy <input type="checkbox"/> Others		
	Others	<input type="checkbox"/> Socket <input type="checkbox"/> Bevel End <input type="checkbox"/> Others <input type="checkbox"/>			
Filled Arch		<input type="checkbox"/> Yes <input type="checkbox"/> No <input type="checkbox"/> <input type="checkbox"/>			
Control Unit		<input type="checkbox"/> Yes <input type="checkbox"/> No <input type="checkbox"/> <input type="checkbox"/>			
Movement	Lateral	<input type="checkbox"/> 20mm <input type="checkbox"/> 50mm <input type="checkbox"/> 100mm <input type="checkbox"/> 200mm <input type="checkbox"/> 300mm <input type="checkbox"/> 400mm <input type="checkbox"/> Others ()mm			
	Elongation	()mm			
	Compression	()mm			
Medium					
Pressure	Normal	() <input type="checkbox"/> MPa <input type="checkbox"/> Kgf/cm ² <input type="checkbox"/> Bar <input type="checkbox"/> psi. <input type="checkbox"/> mmHg <input type="checkbox"/> mmAq			
	Max.	() <input type="checkbox"/> MPa <input type="checkbox"/> Kgf/cm ² <input type="checkbox"/> Bar <input type="checkbox"/> psi. <input type="checkbox"/> mmHg <input type="checkbox"/> mmAq			
Temperature	Normal	() <input type="checkbox"/> °C <input type="checkbox"/> °F			
	Max.	() <input type="checkbox"/> °C <input type="checkbox"/> °F			
Quantity		() pcs.			
Drawing		<input type="checkbox"/> Yes () copies <input type="checkbox"/> No			
Required Inspection					
Delivery		() days after receipt of order			
Remarks					



TOZEN (THAILAND) CO., LTD.

3388/62 18TH FLOOR, SIRINRAT BLDG.,
RAMA IV RD., BANGKOK 10110 THAILAND
TEL : (66) 0-2367-5721-8
FAX : (66) 0-2367-5729, 0-2367-5066
URL : www.tozen.co.th

TOZEN CORPORATION

8-4, ASAHY YOSHIKAWA
SAITAMA 342-008 JAPAN
TEL : 048-993-1030
FAX : 048-993-1038